



Hella marine



Turn up the party, Select the mood,
Switch on the fish magnets.



APELO

Underwater lighting brilliance

APELO

Turn up the party, select the mood, switch on the fish magnets.

Apelo underwater brilliance by Hella marine lets you do it all.

Select between incredibly vibrant blue or intense white for amazing illumination experiences.

Take complete control and choose any colour you wish with Apelo RGB.



Apelo A1 1800 Lumen

- Vibrant blue and intense white illumination, or select Apelo RGB* for complete control of the colour spectrum.
- Optical Intelligence: Wide horizontal illumination with a narrow vertical angle for spectacular effect.
- Corrosion resistant thermal polymer housing and Grilamid high strength nylon lens.
- Completely sealed and electronically protected.
- Robust surface mount design.
- Advanced thermal management ensuring ongoing protection and no damage by operation out of the water.
- Charcoal or white front.
- Suitable for hulls of any material.

Blue / White



RGB*



Specifications	
Lumens	1800 (White)
Lens Material	Grilamid. A high strength, UV resistant, optical nylon.
Base Material	'Non metal' corrosion resistant thermal polymer housing.
Colour Temperature	6000K (White)
Pre-wired Cable	2.5M / 8.2ft of multi core marine cable
Operating Voltage	9-32V DC
Voltage Protection	Spike protected to +500 volts, Reverse polarity protected to -700 volts.
Power Consumption	Blue/White <20W / <1.67A@12V, <0.83A@24V RGB <15W / <1.25A@12V, <0.63A@24V
Degree of Protection	IP68 and IP69
Weight (incl. cable)	Blue/White 250g, RGB 300g.
Installation	Surface mount with robust mounting system
Diameter	95mm / 3.74"
Approvals	CE, ISO 8846 (Ignition Protection)

* Connect Apelo RGB lamps to an RGB lighting controller for unlimited colour selection.

Apelo A1 Part Numbers

Light Colours	White Front	Charcoal Front
Blue / White	2LT 016 145-011	2LT 016 145-001
RGB	2LT 016 146-011	2LT 016 146-001



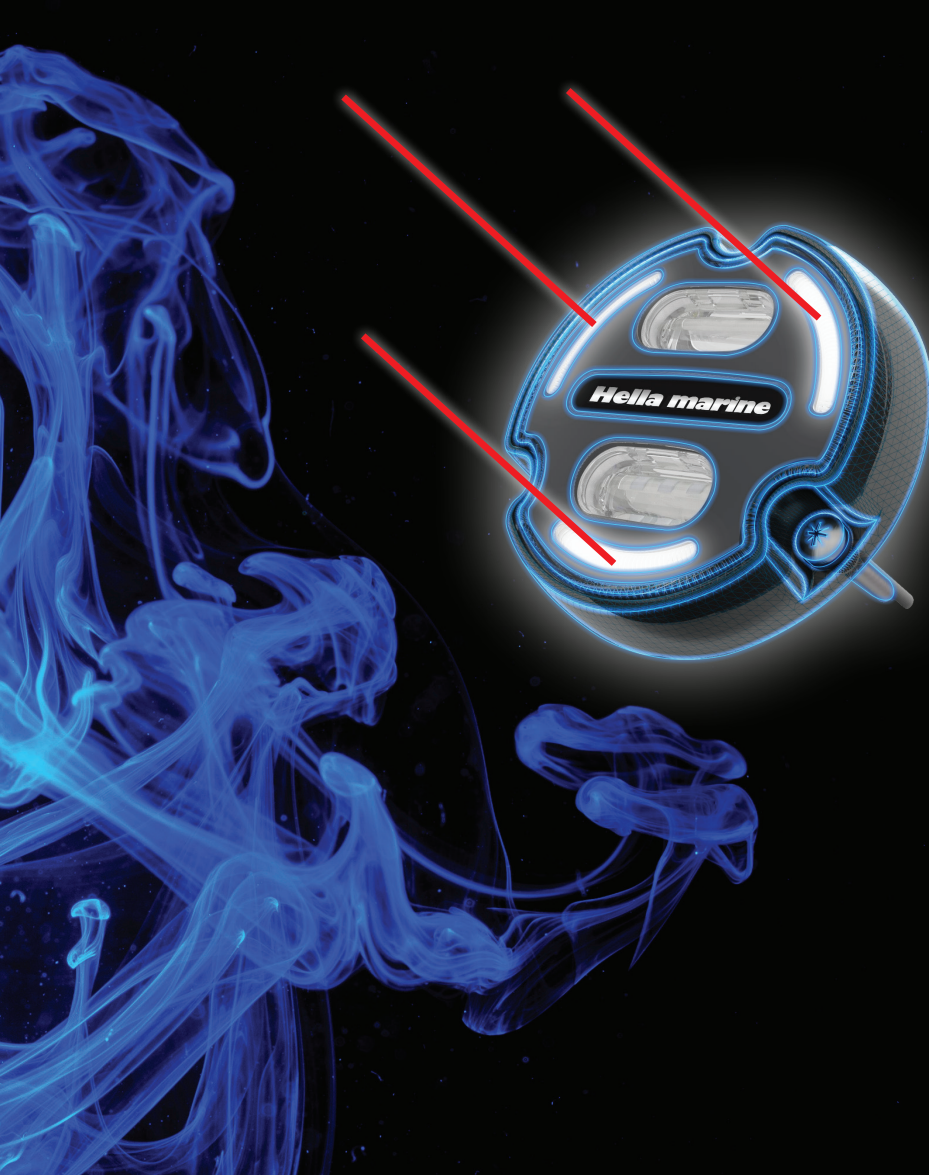

Apelo A2 showcases **Edge Light** technology,

Distinctive glowing signatures of elegant illumination bordering the lamp front.

Light up with **Edge Light** anytime! illuminate your transom with a unique effect whilst launching or retrieving or while sitting on the boat lift. Light up during wash down, flushing engines or when loading gear.

Edge Light is bright enough to shine in daylight without the brilliant intensity of the main Apelo underwater light mode so your friends will not be blinded !

Apelo A2 3000 Lumen



- Vibrant blue and intense white illumination, or select Apelo RGB* for complete control of the colour spectrum.
- Edge Light technology
- Optical Intelligence: Wide horizontal illumination with a narrow vertical angle for spectacular effect.
- Corrosion resistant hard Anodised aluminium housing and Grilamid high strength nylon lens.
- Completely sealed and electronically protected.
- Robust surface mount design.
- Advanced thermal management ensuring ongoing protection and no damage by operation out of the water.
- Suitable for aluminium, fiberglass, timber and composite hulls.

Specifications	
Lumens	3000 (White)
Lens Material	Grilamid. A high strength, UV resistant, optical nylon.
Base Material	Hard anodised corrosion resistant aluminium.
Colour Temperature	5000K (White)
Pre-wired Cable	2.5M / 8.2ft of multi core marine cable
Operating Voltage	9-32V DC
Voltage Protection	Spike protected to +500 volts, Reverse polarity protected to -700 volts.
Power Consumption	White/Blue <30W / <2.5A@12V, <1.25A@24V RGB <30W / <2.5A@12V, <1.25A@24V Edge Light <3W / <0.25A@12V, <0.13A@24V
Degree of Protection	IP68 and IP69
Weight (incl. cable)	Blue/White 310g, RGB 360g.
Installation	Surface mount with robust mounting system
Diameter	95mm / 3.74"
Approvals	CE, ISO 8846 (Ignition Protection)

* Connect Apelo RGB lamps to an RGB lighting controller for unlimited colour selection.



Apelo A2 Aluminium Part Numbers

Light Colours	Charcoal Front
Blue / White	2LT 016 147-001
RGB	2LT 016 148-001

Optical intelligence is the heart of Hella marine lighting.

Apelo introduces a precision engineered optical distribution system efficiently capturing and projecting light. The result is a wide horizontal spread of colour across the water with spectacular effect.

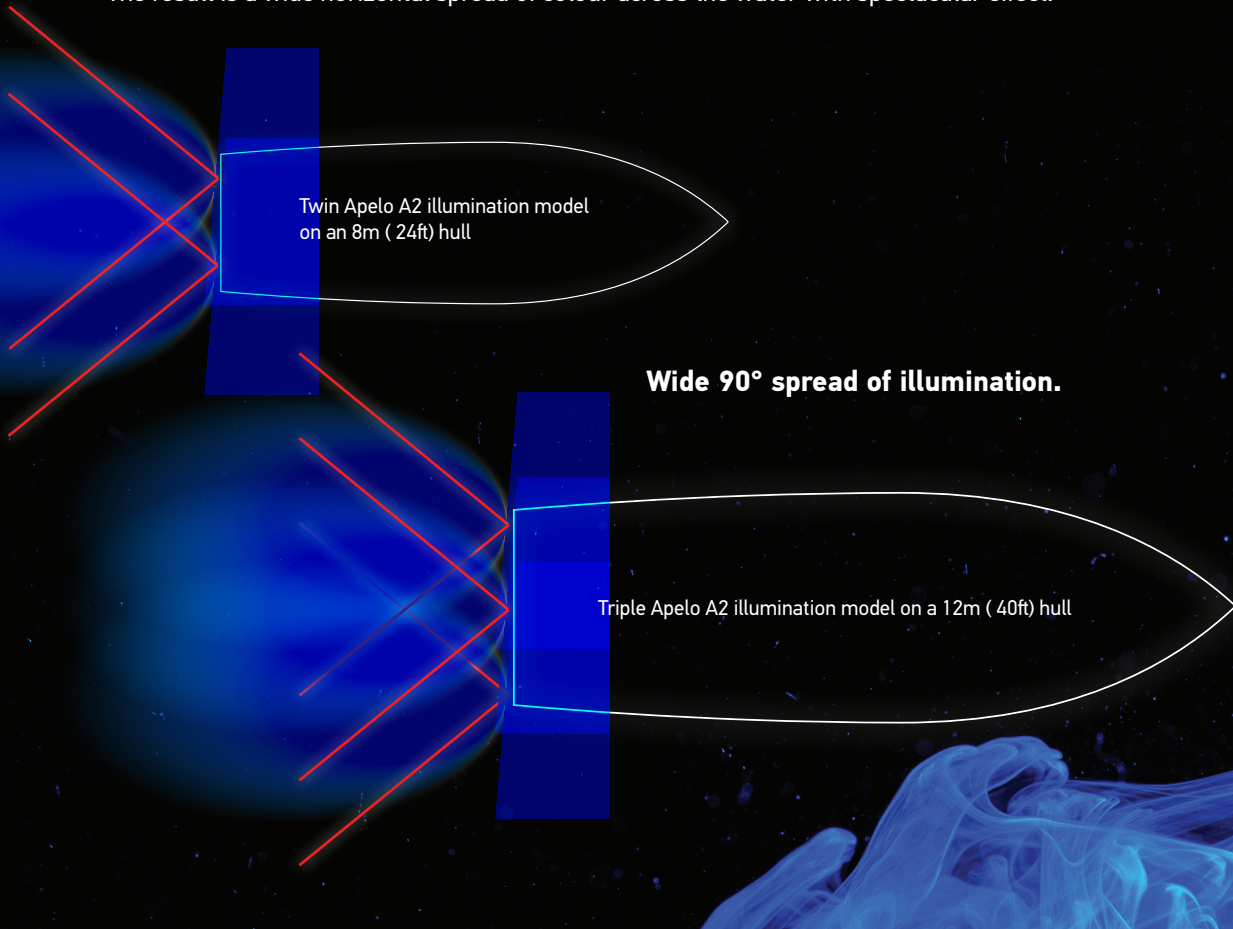

Wide 90° spread of illumination.

Apelo A2 3000 Lumen

- Vibrant blue and intense white illumination, or select Apelo RGB* for complete control of the colour spectrum.
- Edge Light technology.
- Optical Intelligence: Wide horizontal illumination with a narrow vertical angle for spectacular effect.
- Corrosion resistant marine grade bronze housing and Grilamid high strength nylon lens.
- Completely sealed and electronically protected.
- Robust surface mount design.
- Advanced thermal management ensuring ongoing protection and no damage by operation out of the water.
- Suitable for steel, fiberglass, timber and composite hulls.

Specifications

Lumens	3000 (White)
Lens Material	Grilamid. A high strength, UV resistant, optical nylon.
Base Material	Marine grade bronze
Colour Temperature	5000K (White)
Pre-wired Cable	2.5M / 8.2ft of multi core marine cable
Operating Voltage	9-32V DC
Voltage Protection	Spike protected to +500 volts, Reverse polarity protected to -700 volts.
Power Consumption	White/Blue <30W / <2.5A@12V, <1.25A@24V RGB <30W / <2.5A@12V, <1.25A@24V Edge Light <3W / <0.25A@12V, <0.13A@24V
Degree of Protection	IP68 and IP69
Weight (incl. cable)	Blue/White 600g, RGB 650g.
Installation	Surface mount with robust mounting system
Diameter	95mm / 3.74"
Approvals Pending	CE, ISO 8846 (Ignition Protection)

* Connect Apelo RGB lamps to an RGB lighting controller for unlimited colour selection.



Blue / White



RGB*



Edge Light



Apelo A2 Bronze Part Numbers

Light Colours	White Front
Blue / White	2LT 016 147-101
RGB	2LT 016 148-101

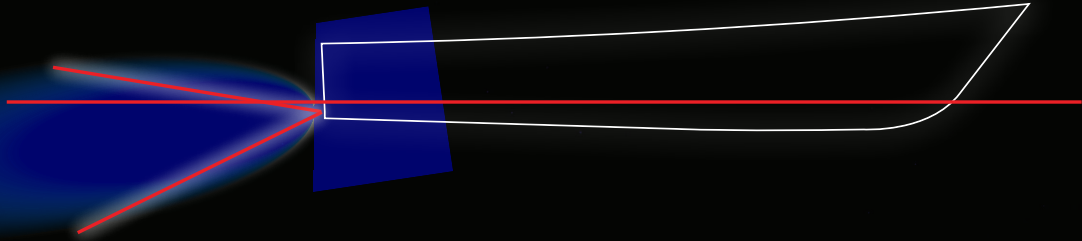

Optical intelligence in action across the transom.

Apelo features an asymmetric light pattern with a narrow vertical angle to focus light efficiently below the waterline.

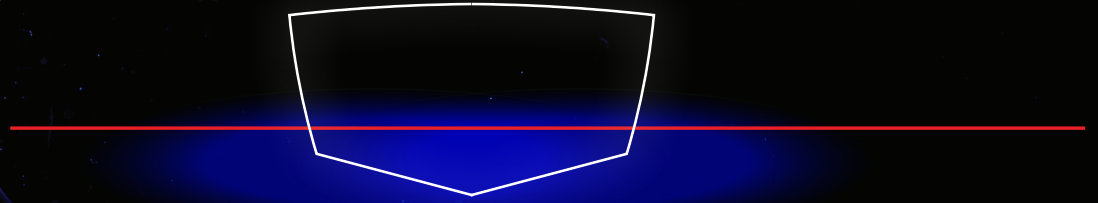
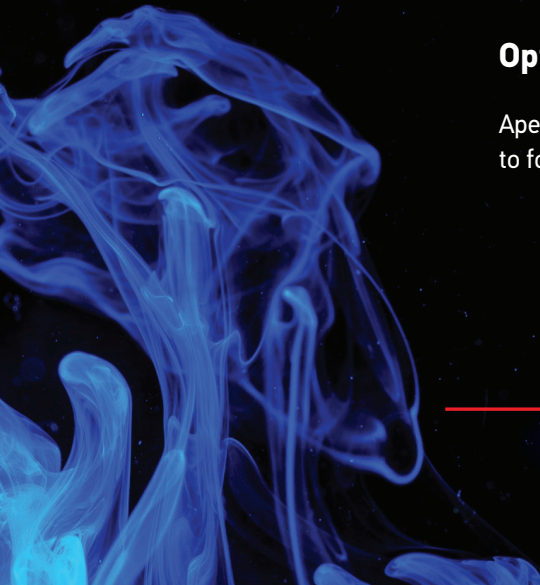

New Zealand Made

Designed and manufactured in New Zealand.



5 Year Warranty

Peace of mind the product will stand the test of time.



Multivolt technology for durability

Full light performance and automatic compensation for low battery voltages and voltage drop across long cables and connections. Reverse polarity and spike protected for enhanced durability even under severe voltage fluctuations.



Electromagnetic Compatibility (EMC)

Apelo components suppress possible interference, preventing possible interference with radio, communication, navigation and other electrical equipment.



IP68 & IP69 - Completely Sealed

Preventing moisture from corroding internal LED electronics is vital for long term durability. Apelo lamps are completely sealed and purpose designed for underwater installations.



Edge Light technology

Apelo A2 showcases Edge Light, distinctive glowing signatures of elegant illumination bordering the lamp front.



Optical Intelligence

Apelo lamps project a wide horizontal spread of colour across the water with spectacular effect. Asymmetric light patterns focus light efficiently below the waterline.



Outstanding UV and Impact Resistance

Apelo features advanced impact resistant polymers that will not yellow or deteriorate even after extreme exposure to UV.



Dry Running Protected

Advanced thermal management ensuring ongoing protection and no damage by operation out of the water.



Lightspeed™ Recommended

Hella marine recommends Lightspeed™ by PropSpeed®, a foul-release coating to protect Apelo underwater lights and maintain their underwater brilliance. Lightspeed™ is tested to provide no decrease in light intensity, no colour shift and no other adverse performance decreases.

Spectacular colour at your fingertips.

APELO

Apelo A1 Blue / White

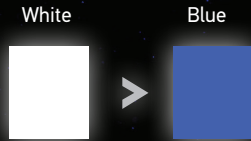

Toggle to select blue or white light.

Apelo A2 Blue / White



Toggle to select constant or strobing blue or white light.

Apelo A1 & Apelo A2 RGB



Connect Apelo RGB lamps to an RGB lighting controller for unlimited colour selection.

Robust Surface Mount Design

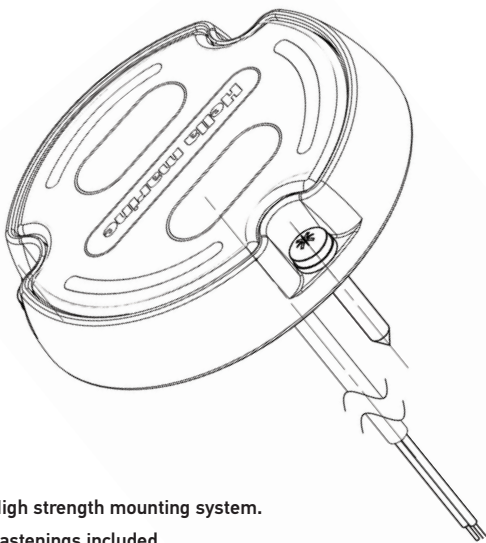

High strength mounting system.
Fastenings included.

Pre-wired with marine cable

Apelo A1 and Apelo A2 Blue / White lamps



Toggle to select constant or strobing blue or white light.

Apelo A1 and Apelo A2 RGB lamps

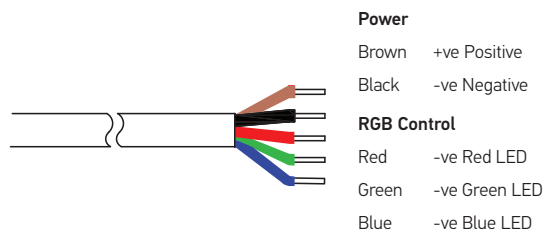

Connect to an RGB controller for unlimited colour control.

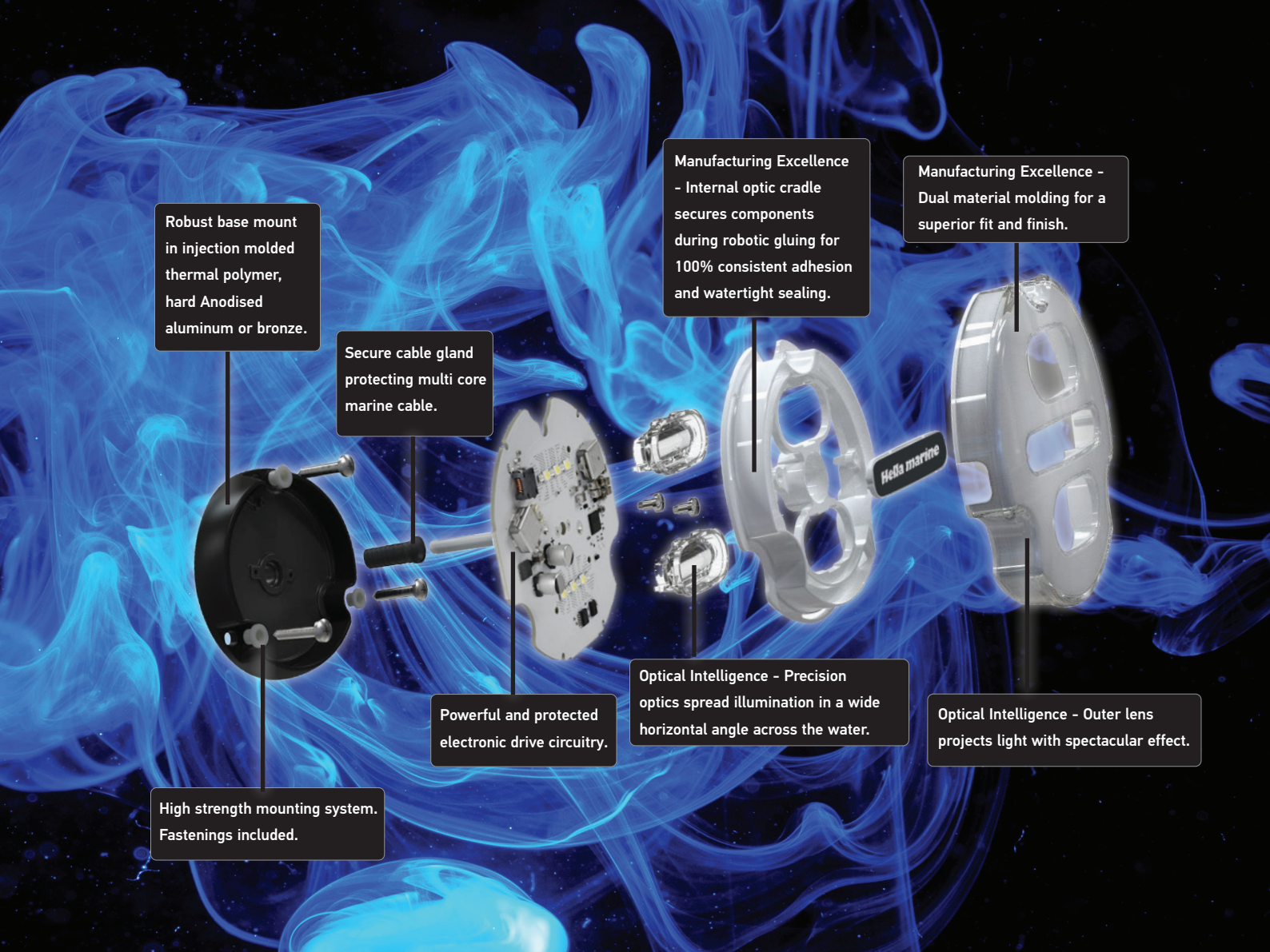

Apelo Dimensions

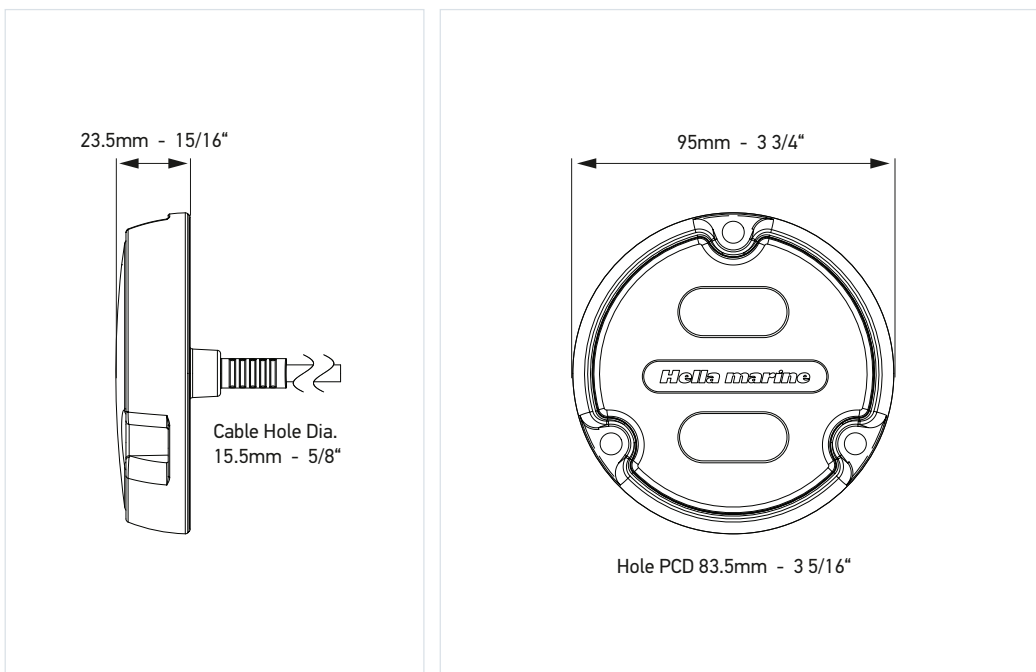



Hella marine



APELO

Underwater lighting brilliance

Austria
Ascherl Botzbehör
Hard (Bregenz)
Tel: +43 557489900-0
office@ascherl.at
www.Ascherl.at

Croatia
M.A.G.-D.D d.o.o.
Šibenik
Tel: +385 22 337-177
info@magdd.hr
magdd.hr

Denmark
Hella A/S
Aabenraa
Tel: +45 73 30 36 11
michael.simonsen@hella.dk
www.hellamarine.com

England
ASAP Supplies
Beccles, Suffolk
Tel: +44 (0) 1502 716993
sales@asap-supplies.com
www.asap-supplies.com

Furneaux Riddall
Portsmouth
Tel: +44 23 9266 8621
sales@furneauxriddall.com
www.furneauxriddall.com.

Western Electrical
Plymouth
Tel: +44 (0)1752 484290
sales@eel.co.uk
www.westernmarinesales.co.uk

Estonia
KGK Knutsson AS
Tallinn
Tel: +372 6519300
kgk@kgk.ee

France
Hella France
Le Blanc Mesnil
Tel: +33 1 49 39 59 59
Fax: +33 1 49 39 59 06
hellamarine.france@hella.com
www.hellamarine.com

VDM Reya
La Garde
Tel: +33 (0)7 63 95 73 35
Fax: +33 (0)4 94 08 77 79
b.massard@vdm-reya.com
www.vdm-reya.com

Finland
OY Maritim AB
Helsinki
Tel: +358-207-652705
Fax: +358-207 652 945
info@maritimshops.fi
www.Maritim.Fi

Germany
Hella GmbH & Co. KG
Lippstadt
Tel: +49 2941-386644
rita.mueller@hella.com
www.hellamarine.com

Bukh Bremen
Bremen
Tel: +49(0)421-53507-0
info@bukh-bremen.de
www.bukh-bremen.de

Greece
Nautilus Yacht Equipment S.A.
55132 Thessalokini
Tel: +30 (0)210 9855300
info@nautilus.gr
www.nautilus.gr

D. Koronakis S.A.
18545 Piraeus
Tel: +30 (0)210 4060600
marine@koronakis.gr
www.koronakis.gr

Italy
Motomarine SRL
Trieste
Tel: 040/225571
info@motomarine.it
www.motomarine.it

N.E.E.A. Srl
Sanremo
Tel: 0184/513161
Fax: 0184/513168
marcomartini@neearl.com
www.neearl.com

Latvia
KGK Knutsson SIA
Mārupe
Tel: +371 26 499 811
kgk@kgk.lv
www.kgk.lv

Netherlands
HELLA Marine Europe
3439 NC Nieuwegein
M: +31 (0)6-51336164
rene.van.miltenburg@hella.com
www.hellamarine.com

Exalto
Hardinxveld- Giessendam
Tel: +31 184615800
sales@exalto.com
www.exalto.com

Allpa
Nijmegen
Tel: +31 243777773
info@allpa.nl
www.Allpa.nl

Norway
NDS - Nordic Distribution & Service
Skytta
Tel: +47 67 06 60 00
Fax: +47 67 06 60 10
marine@nds-group.no
www.nds-group.no

Norway Marine Supply AS
Arendal
Tel: +47 37 00 03 50
salg@nmsproff.no
www.nmsproff.no

Poland
Eljacht
Gdansk
Tel: +48 583207024
info@eljacht.pl
www.eljacht.pl

Portugal
Nautiradar
Lisboa
Tel: +351 213005050
commercial@nautiradar.pt
www.nautiradar.pt

Slovenia
Stal Mar d.o.o
Ljubljana
Tel: +386 14233540
info@stal.si
www.stalmar.si

Spain
Imnasa
Girona
Tel: +34 90210334
info@imnasa.com
www.imnasa.com

Sweden
KGK Knutsson AB
Stockholm
Tel: +46 (0)8-92 30 00
Support@kgk.se
www.marinkatalogen.se

Turkey
MARİNTEK DENİZ VE YAT MALZEME LERİ TİC. A.Ş.
İstanbul
Tel: +90 216 317 1010
aytug@marintek.com.tr
www.marintek.com

Apelo A1 1800 lumen

Thermal Polymer Housing

Blue / White



RGB



Light Colours	White Front	Charcoal Front
Blue / White	2LT 016 145-011	2LT 016 145-001
RGB	2LT 016 146-011	2LT 016 146-001

Apelo A2 3000 lumen

Hard Anodised Aluminium Housing with Edge Light

Blue / White



RGB



Edge Light



Light Colours	Charcoal Front
Blue / White	2LT 016 147-001
RGB	2LT 016 148-001

Apelo A2 3000 lumen

Marine Grade Bronze Housing with Edge Light

Blue / White



RGB



Edge Light



Light Colours	White Front
Blue / White	2LT 016 147-101
RGB	2LT 016 148-101



www.Apelobrilliance.com



facebook.com/hellamarine
linkedin.com/company/hella-marine
youtube.com/user/hellamarine